

SUPER ★ Star

Workbook

3



A* List

Contents



Sports Day 4



At the Park 12

long vowel a
-ake -ase -ate
-ame -ape -ave

Phonics 1 20



Art Class 22



Lunch Time 30

long vowel i
-ice -ike -ine
-ide -ite -ive

Phonics 2 38



Job 40



Summer Camp 48

long vowel o&u
-ole -ope -ose
-ube -une -ute

Phonics 3 56



Clothing 58



Neighborhood 66

-ai -ay -ea
-ee -oa -ow

Phonics 4 74

Unit 1 Sports Day

Lesson 1

Conversation



A Read and check.

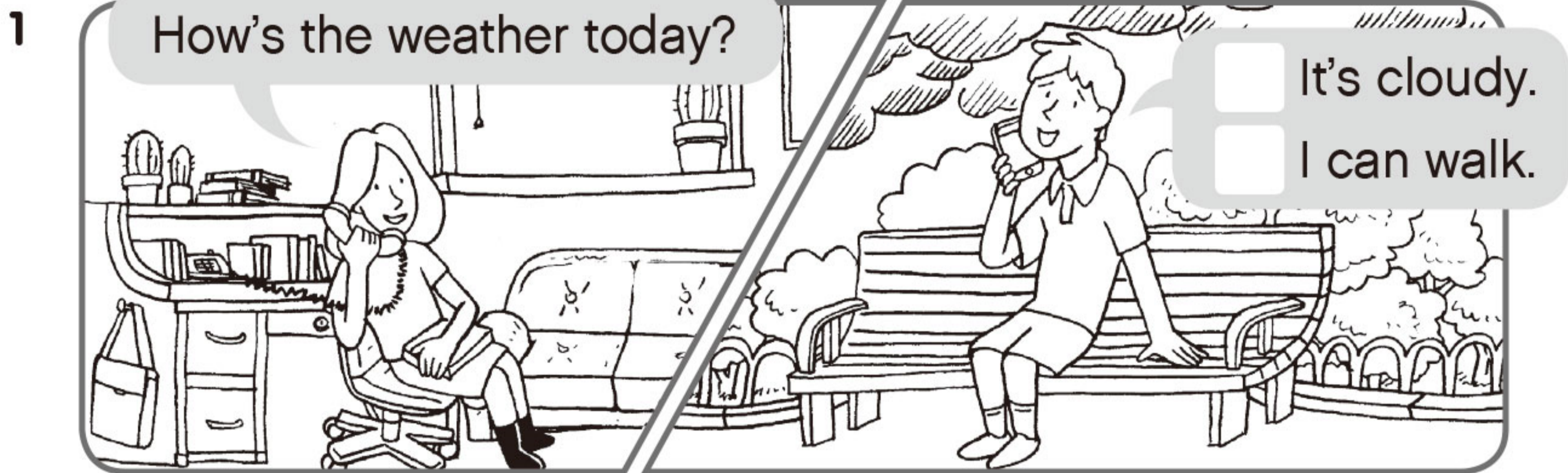

B Read and number.

- 1 windy 2 How's 3 snowy 4 sunny 5 weather 6 It's

1 _____ the
_____ today?



2 It's _____ today.



3 _____ rainy.



4 It's _____ today.



5 It's _____.



C Unscramble and write.







1 today How's weather the

_____?



2 sunny It's today

_____.

A Look and circle.

1 	2 	3 	4 	5 
kick ----- jump	clap ----- walk	sing ----- kick	kick ----- clap	jump ----- sing

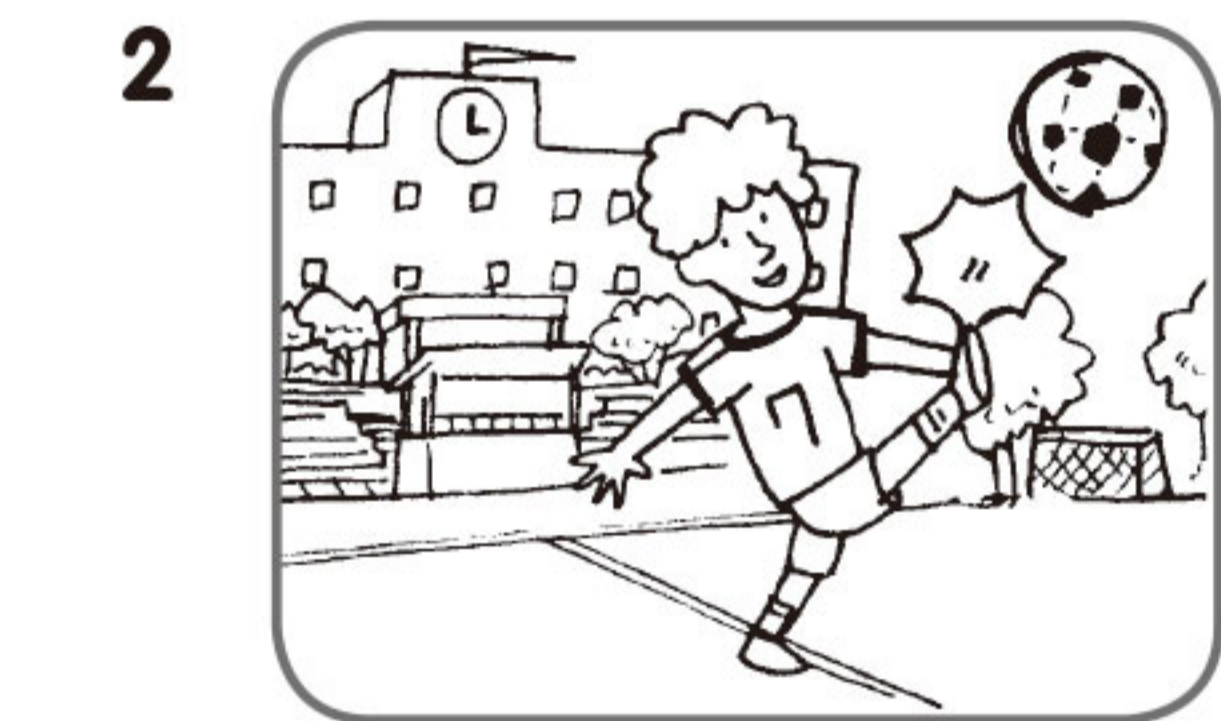

B Look and check.

1 	2 	3 
--	---	--

- I can't sing.
- I can't clap.

- I can't clap.
- I can kick.

- I can walk.
- I can't sing.

4 	5 
---	--

- I can jump.
- I can't clap.

- I can kick.
- I can't walk.

C Look and circle.

1



He can kick.
She can't sing.

2



He can walk.
She can't clap.

3



He can jump.
She can't

4



He can kick.
She can't clap.

D Circle and write.

1



He She can't kick

_____.

2



I can can't jump sing

_____.

A Look and find.

1 

rearrunacek

2 

danceorske

3 

skereswim

4 

erskateger

5 

cclimbsers

B Look, read, and match.



What can you do?

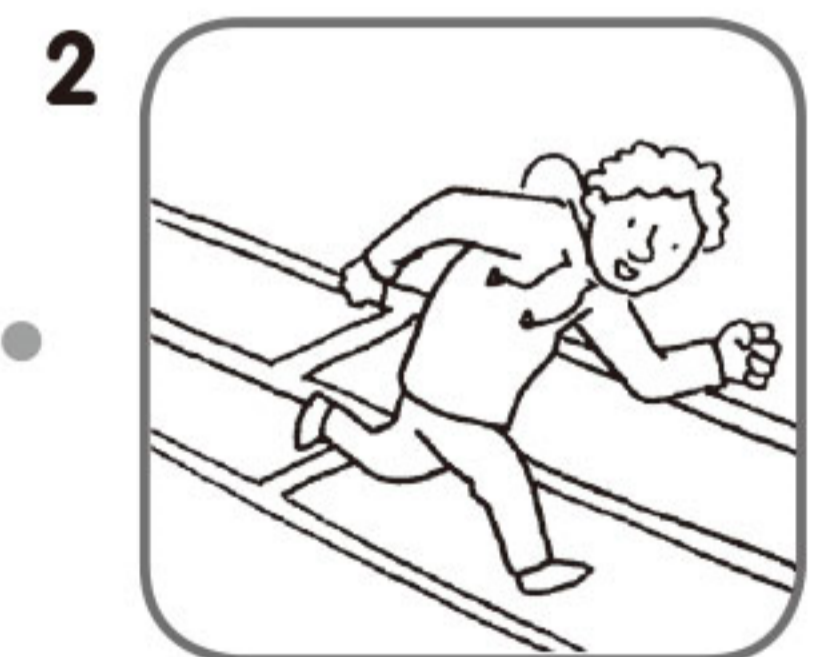

• I can run. •

• I can swim. •

• I can skate. •

• I can climb. •

C Read and number.

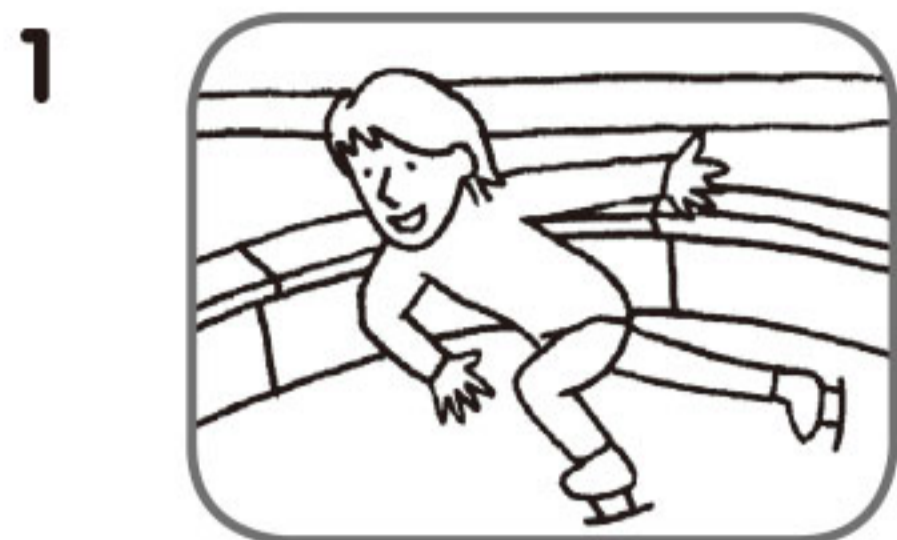

What _____ he do?

He can _____.



_____ can he do?

_____ can _____.



What can she _____?

She can _____.

1 climb

2 He

3 dance

4 What

5 do

6 can

7 skate

D Look, write, and check.



What _____?

I can run.

I can swim.



What _____?

She can skate.

She can dance.



_____?

She can climb.

She can skate.



_____?

He can swim.

He can run.